

Article number: 20273001

Description: E+G
Indexing plunger GN 822-5-C-ST

Measures

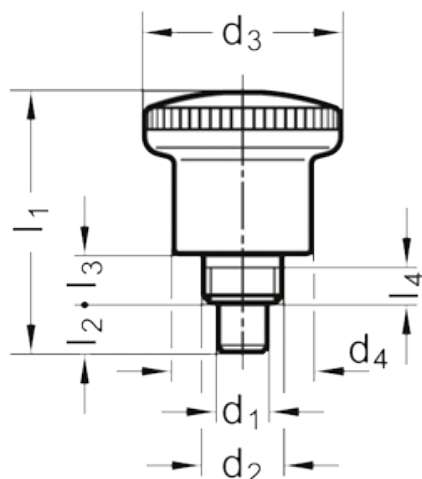

6 indexing positions

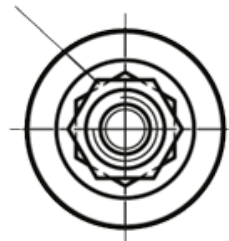

Type C
(Knob rotated by 30°)

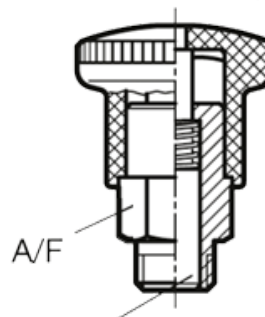

Plunger pin
retracted

A/F	= 10	l4 min.	= 3.5
d1	= 5	Spring load end	= 12
d2	= M 8 x 0.75	Spring load initial	= 4.5
d3	= 21	Weight in (g)	= 14
d4	= 15		
l1	= 26.5		
l2 min.	= 5		
l3	= 5		